

Register your product and get support at
www.philips.com/welcome

CID3692



EN User manual

ZH-HK 使用手冊

ZH-CN 用户手册

PHILIPS

部件名称 Name of the Parts	有毒有害物质或元素 Hazardous/toxic Substance					
	铅 (Pb, Lead)	汞 (Hg, Mercury)	镉 (Cd, cadmium)	六价铬 (Chromium 6+)	多溴联苯 (PBB)	多溴二苯醚 (PBDE)
Housing 外壳	○	○	○	○	○	○
DVD/CD loader DVD/CD 光盒	×	○	○	○	○	○
LCD Panel 液晶面板	×	×	○	○	○	○
PWBs 电路板组件	×	○	○	○	○	○
Accessories (Remote control & cables) 附件 (遥控器, 电 源线, 连接线)	×	○	○	○	○	○
Batteries in Remote Control (ZnC) 遥控器电池	×	○	○	○	○	○

○：表示该有毒有害物质在该部件所有均质材料中的含量均在SJ/T11363 - 2006 标准规定的限量要求以下。

○: Indicates that this toxic or hazardous substance contained in all of the homogeneous materials for this part is below the limit requirement in SJ/T11363 – 2006.

×：表示该有毒有害物质至少在该部件的某一均质材料中的含量超出SJ/T11363 - 2006 标准规定的限量要求。

X:Indicates that this toxic or hazardous substance contained in at least one of the homogeneous materials used for this part is above the limit requirement in SJ/T11363 - 2006.



环保使用期限 Environmental Protection Use Period

This logo refers to the period (10 years)

电子信息产品中含有的有毒有害物质或元素在正常使用的条件下不会发生外泄或突变，电子信息产品用户使用该电子信息产品不会对环境造成严重污染或对其人身、财产造成严重损害的期限。

This logo refers to the period (10 years) during which the toxic or hazardous substances or elements contained in electronic information products will not leak or mutate so that the use of these [substances or elements] will not result in any severe environmental pollution, any bodily injury or damage to any assets.

Contents

1 Important	4
Safety	4
Notice	4
2 Your in-car entertainment system	6
Introduction	6
What's in the box	6
Overview of the main unit	7
3 Get started	8
Install the car audio	8
Turn on	11
Adjust screen	11
Set date and time	11
4 Use map	12
Upgrade the map	12
5 Listen to radio	13
Tune to a radio station	13
Store radio stations in memory	14
Tune to a preset station	14
6 Play	15
Load discs	15
Connect USB device	15
Insert USB or SD/MMC card	15
Play/Pause	16
Skip/search	16
Search within a title/folder	16
Repeat	17
Repeat a section	17
Random play	17
Select audio language	17
Select audio mode	18
Select subtitle language	18
Rotate pictures	18
Zoom	18
Select slide show duration	18
7 Play with Bluetooth device	19
Pair the Bluetooth-enabled devices	19
Make a call	19
Receive call	20
Listen to music from Bluetooth device	20
Adjust Bluetooth settings	20
8 Adjust sound	21
Adjust volume	21
Mute	21
Select preset equalizer	21
Adjust fader/balance	22
Set Dynamic Bass Boost (DBB)	22
9 Adjust settings	23
Display system setup menu	23
Adjust general settings	23
Adjust sound settings	24
Adjust video settings	24
Adjust Bluetooth settings	25
Adjust language settings	25
Adjust volume settings	26
Adjust DVD rating	26
10 Others	27
Listen to other devices	27
Reset	27
Remove the unit	27
Replace fuse	28
11 Product information	28
12 Troubleshooting	30
About Bluetooth device	30
13 Glossary	32

1 Important

Safety

- Read and understand all instructions before you use the apparatus. If damage is caused by failure to follow instructions, the warranty does not apply.
- Use of controls or adjustments or performance of procedures other than herein may result in hazardous radiation exposure or other unsafe operation.
- This unit is designed for negative ground (earth) 12 V DC operation only.
- To reduce the risk of traffic accident, do not watch video during driving.
- To ensure safe driving, adjust the volume to a safe and comfortable level.
- Improper fuses can cause damage or fire. When you need to change the fuse, consult a professional.
- Use only the supplied mounting hardware for a safe and secure installation.
- To avoid short circuit, do not expose the apparatus, remote control or remote control batteries to rain or water.
- Never insert objects into the ventilation slots or other openings on the apparatus.
- Never place any objects other than discs into the disc tray/slot.
- Visible and invisible laser radiation when open. Avoid exposure to beam.
- Risk of damage to the screen! Never touch, push, rub or strike the screen with any object.
- Never use solvents such as benzene, thinner, cleaners available commercially, or anti-static sprays intended for discs.
- Clean the apparatus with soft, damp cloth. Never use substances such as alcohol, chemicals or household cleaners on the apparatus.
- The apparatus shall not be exposed to dripping or splashing.

- Do not place any sources of danger on the apparatus (e.g. liquid filled objects, lighted candles).

Notice

Any changes or modifications made to this device that are not expressly approved by Philips Consumer Lifestyle may void the user's authority to operate the equipment.

Environmental information

All unnecessary packaging has been omitted. We have tried to make the packaging easy to separate into three materials: cardboard (box), polystyrene foam (buffer) and polyethylene (bags, protective foam sheet).

Your system consists of materials which can be recycled and reused if disassembled by a specialized company. Please observe the local regulations regarding the disposal of packaging materials, exhausted batteries and old equipment.

Recycling



Your product is designed and manufactured with high quality materials and components, which can be recycled and reused. When you see the crossed-out wheel bin symbol attached to a product, it means the product is covered by the European Directive 2002/96/EC:



Never dispose of your product with other household waste. Please inform yourself about the local rules on the separate collection of electrical and electronic products. The correct disposal of your old product helps prevent potentially negative consequences on the environment and human health.

Your product contains batteries covered by the European Directive 2006/66/EC, which cannot be disposed of with normal household waste.

Please inform yourself about the local rules on separate collection of batteries. The correct disposal of batteries helps prevent potentially negative consequences on the environment and human health.



This product complies with the radio interference requirements of the European Community.



The making of unauthorized copies of copy-protected material, including computer programs, files, broadcasts and sound recordings, may be an infringement of copyrights and constitute a criminal offence. This equipment should not be used for such purposes.



"DivX, DivX" Certified, and associated logos are trademarks of DivX, Inc. and are used under license.

Official DivX[®] Certified product. Plays all versions of DivX[®] video (including DivX[®] 6) with standard playback of DivX[®] media files. The Bluetooth[®] word mark and logos are registered trademarks owned by Bluetooth SIG, Inc. and any use of such marks by Philips is under license.



Manufactured under license from Dolby Laboratories.

"Dolby" and the double-D symbol are trademarks of Dolby Laboratories. Other trademarks and trade names are those of their respective owners.

This apparatus includes this label:



2010 © Koninklijke Philips Electronics N.V. All rights reserved.

Specifications are subject to change without notice. Trademarks are the property of Koninklijke Philips Electronics N.V. or their respective owners. Philips reserves the right to change products at any time without being obliged to adjust earlier supplies accordingly.

2 Your in-car entertainment system

Congratulations on your purchase, and welcome to Philips! To fully benefit from the support that Philips offers, register your product at www.philips.com/welcome.

Introduction

With the car entertainment system, you can:

- quickly find routine through the navigation system
- enjoy audio/video/JPEG pictures from
 - DVD, VCD or CD
 - USB devices
 - SD/SDHC/MMC cards
 - External devices
- listen to FM or AM (MW) radio
- play audio from Bluetooth-enabled devices
- make/receive phone calls with Bluetooth-enabled devices

What's in the box

Check and identify the contents of your package:

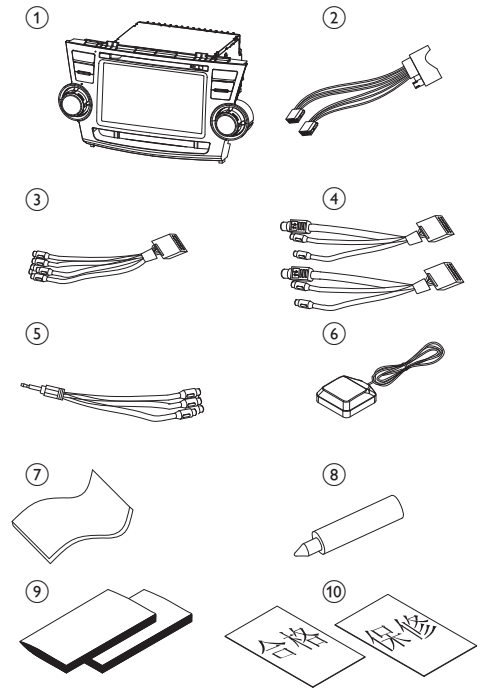

- ① Main unit x 1
- ② Power cable x 1
- ③ Output cable x 1
- ④ Connection cable x 2
- ⑤ AV out cable x 1
- ⑥ GPS antenna x 1
- ⑦ Cleaning cloth x 1
- ⑧ Stylus pen x 1
- ⑨ Printing materials (include User manual, Quick start guide, Installation guide)
- ⑩ QC card / Guarantee card

Overview of the main unit

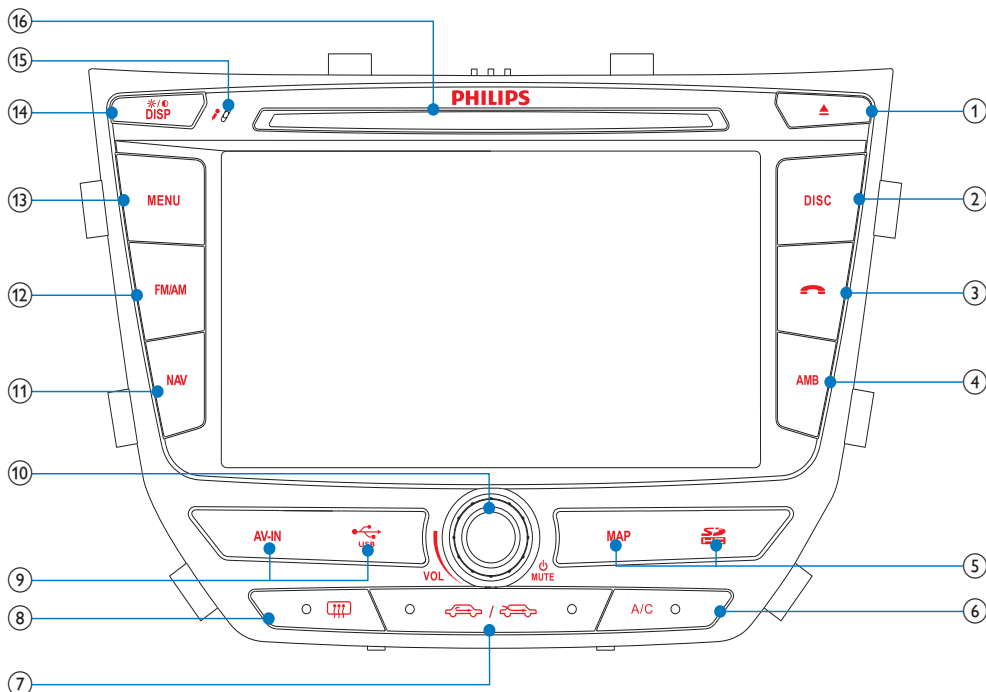

- ① ▲
 - Eject disc.
- ② DISC
 - Select the disc source.
- ③ 📞
 - Terminate call.
- ④ AMB
 - Display the air conditioning information.
- ⑤ 🗺️/MAP
 - Open the cover and insert/remove the SDHC/GPS map card.
- ⑥ A/C
 - Turn on/off the air conditioner.
- ⑦ 🚗 / 🚗
 - Select in-car air recycling system/air refreshing system.
- ⑧ 🗄️
 - Turn on the rear window defroster.
- ⑨ AV IN/🔌
 - Open the cover and connect the AV IN/USB device.
- ⑩ ⏻/MUTE/VOL
 - Turn the unit on or off.
 - Mute or unmute audio.
 - Adjust volume.
- ⑪ NAV
 - Enter the GPS navigation system or exit.
- ⑫ FM/AM
 - Switch to the FM/AM source.
- ⑬ MENU
 - Return to the home menu.

⑭ DISP/⊗/●

- Adjust screen brightness.
- Turn on/off the screen display.

⑮

- Built-in microphone for phone calls.

⑯ Disc slot

3 Get started



Caution

- Use of controls or adjustments or performance of procedures other than herein may result in hazardous radiation exposure or other unsafe operation.

Always follow the instructions in this chapter in sequence.

Install the car audio

These instructions are for a typical installation. However, if your car has different requirements, make the corresponding adjustment. If you have any questions regarding installation kits, consult your Philips car audio dealer.



Caution

- This unit is designed for negative ground (earth) 12 V DC operation only.
- Always install this unit in the car dashboard. Other locations can be dangerous as the rear of the unit heats up during use.
- To avoid short-circuit: before you connect, ensure that the ignition is off.
- Ensure that you connect the yellow and red power supply leads after all other leads are connected.
- Ensure that all loose leads are insulated with electrical tape.
- Ensure that the leads do not get caught under screws or parts that will move (e.g. seat rail).
- Ensure that all ground (earth) leads are run to a common ground (earth) point.
- Use only the supplied mounting hardware for a safe and secure installation.
- Improper fuses can cause damage or fire. When you need to change the fuse, consult a professional.

Note on the power supply lead (yellow)

- When you connect other devices to this system, ensure that the rating of the car circuit is higher than the total fuse value of all the connected devices.

Notes on speaker connection

- Never connect speaker wires to the metal body or chassis of the car.
- Never connect speaker wires with stripes to one another.

Connect wires



Caution

- Ensure that all loose leads are insulated with electrical tape.

- 1 Check the car's wirings carefully, then connect them to the unit.

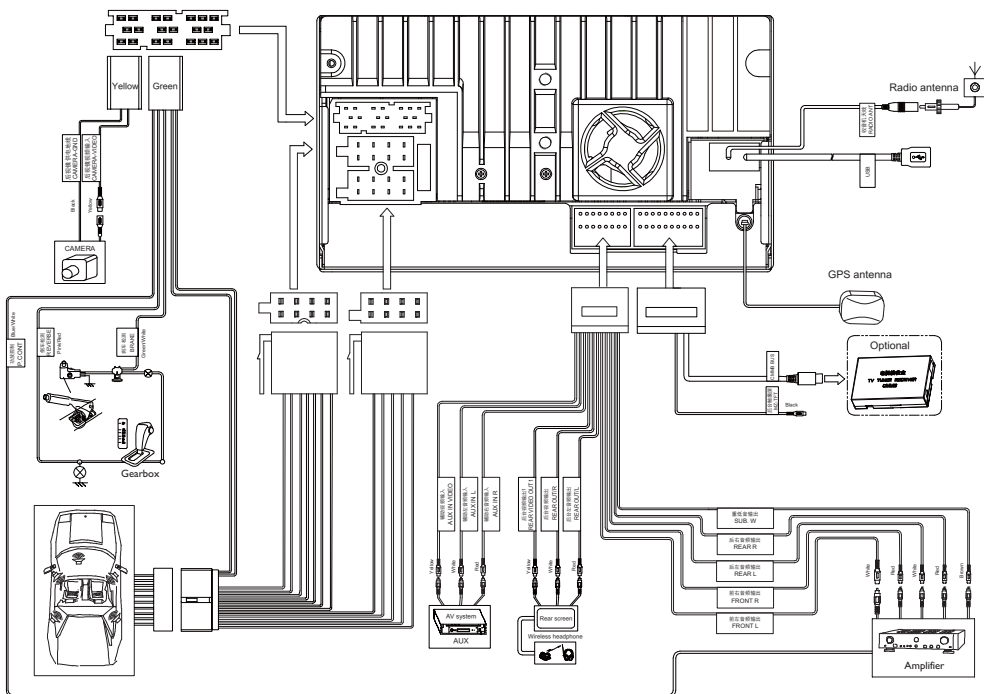

Connect GPS antenna

To receive signal from satellites, connect the supplied GPS antenna to your car and the system.

- 1 Connect the supplier GPS antenna to the system first.

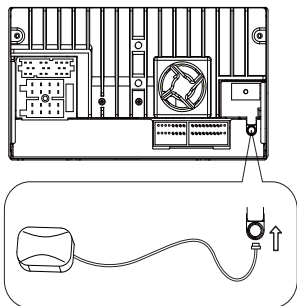

- 2 Stick the other end of the GPS antenna to a metal surface of the car.

Connect radio antenna

If your car has built-in radio antenna, connect it to the radio antenna of the system for better radio signal.

- 1 Connect the radio antenna to the car antenna.

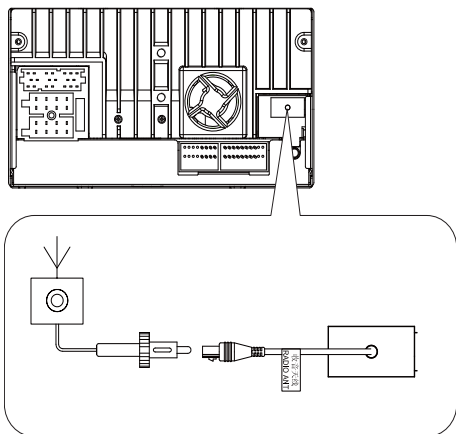

Mount in the dashboard

Note

- Check wire connections before you mount the unit into a car.
- If preset radio stations are lost when the ignition key is turned OFF and then back ON, reconnect the red leads crosswise to the yellow ones.

- 1 If the car does not have an on-board drive or navigation computer, disconnect the negative terminal of the car battery.
 - If you disconnect the car battery in a car that has an on-board drive or navigation computer, the computer may lose its memory.
 - If the car battery is not disconnected, to avoid short-circuit, ensure that bare wires do not touch each other.
- 2 Ensure that the horizontal slant of the car dashboard opening is between 0 and 20 degrees. The unit cannot be used if the dashboard opening's slant angle is above 20 degrees.
- 3 Fix the mounting brackets to the unit with screws (supplied by the car manufacturer).

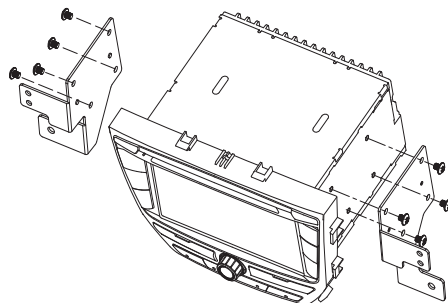

- 4 Slide the unit into the dashboard and fix it to the car with four screws.

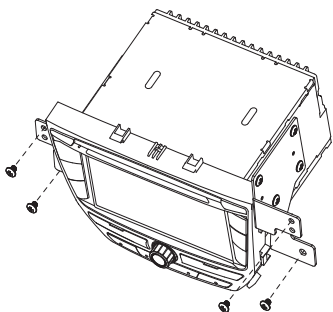

- 5 Reconnect the negative terminal of the car battery.

Turn on

! Caution

- Risk of road accidents! Never watch video or adjust settings while you drive.

- 1 Press and hold **MUTE/VOL** to turn on the unit.
 - ↳ The available OSD (On-Screen Display) languages are displayed.



- 2 Tap a language to select.
 - ↳ The OSD language is changed to the selected language immediately.
- To turn off the unit, press and hold **MUTE/VOL**.

Adjust screen

To adjust screen brightness

- 1 Press **DISP/☼/⦿** to show the brightness bar.
- 2 Tap **◀▶** to adjust the value.
- 3 Press **DISP/☼/⦿** to confirm.
 - To turn on/off the screen, press and hold **DISP/☼/⦿**.

Set date and time

- 1 Tap the upper left corner to display the main menu.



- 2 Tap **◀** in the middle right side of the screen.
 - ↳ The second main menu is displayed.

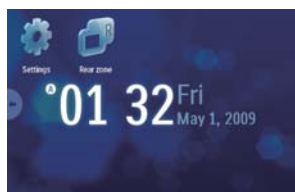

- 3 Tap **[Settings]**.
- 4 Tap **[Time]**.
 - ↳ The date/time setup menu is displayed.



Set date

- 1 Tap [Date].
- 2 Tap on the displayed date information.
↳ A submenu is displayed.



- 3 Tap ▲ or ▼ to set year, month and day.

Set clock mode

- 1 Tap [Clock mode].



- 2 Tap on [12Hr] or [24Hr] to select clock mode.

Set time

- 1 Tap [Time].
- 2 Tap on the displayed time.
↳ A submenu is displayed.

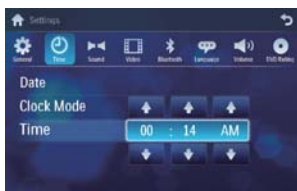

- 3 Tap ▲ or ▼ to set hour and minute.

Tip

- When date/time is set, tap ↶ first and then tap ▶ to return to the main menu.

4 Use map

Note

- You may need to upgrade the map (sold separately) before using it (see "Upgrade the map" section)

- 1 Tap the upper left corner to display home menu.
- 2 Tap [Navigation].
↳ The navigation menu is displayed in a few seconds.
- 3 Refer to the map manual to operate the navigation tool.

Tip

- You can press NAV to enter/exit the navigation system.

Upgrade the map

- 1 Turn off the car audio system.
- 2 Open the MAP/SD card socket cover.
- 3 Press the map card (sold separately) until you hear a click sound.
- 4 Take out the card and bring it to the authorized service center for upgrade.

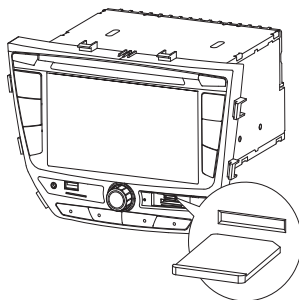





- 5 Insert the upgraded map card back into the map card slot.
- 6 Turn on the car audio.
 - ↳ The map upgrades in a few minutes.

5 Listen to radio

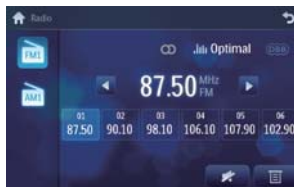
Tune to a radio station

- 1 Tap  to display the home menu.
- 2 Tap **[Radio]**.
 - ↳ Band and frequency information is displayed.





- 3 Tap on **FM** or **AM** to select band:
 - FM band options: **FM1**, **FM2**, **FM3**
 - AM band options: **AM1**, **AM2**
- 4 Briefly tap  or  to tune to a radio station by step.
 - Tap  or  for more than 1 second to tune to a radio station automatically.

Tune by frequency

- 1 Tap **FM** or **AM** to select band.
- 2 Tap .
- 3 Tap **[Goto]**.
- 4 Tap the numbers to enter frequency.



- Tap  to clear the last entered number.
- Tap  to clear all the entered numbers.

- 5 Tap ✓ to confirm.
↳ The radio station is broadcast.

Select radio range

Before you start to search for radio stations, you can select radio range.

- 1 Tap .
- 2 Tap **[Radio range]** to toggle tuner sensitivity from normal to high sensitivity.
 - **[Distance]**: Only stations with strong signals can be broadcast.
 - **[Local]**: Stations with strong and weak signals can be broadcast.

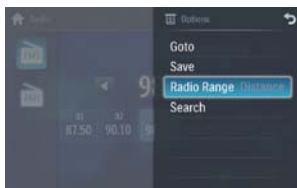

Store radio stations in memory

You can store up to 6 stations in each band.

Store stations manually

- 1 Tune to the station.
- 2 Tap .
- 3 Tap **[Save]**.
- 4 Tap one of the channels **01** to **06** to save the select band.



Store stations automatically

You can search for a station with intro search, which broadcasts a 10-second preview of each detected radio station.

- 1 Select band.
- 2 Tap .
- 3 Tap **[Search]**.
↳ Auto search starts. The six strongest stations of the selected band are saved in preset channels 1-6 automatically.

Tune to a preset station

- 1 Tap **[Radio]**.
- 2 Select band.
- 3 Tap one of the preset channels (**01** to **06**) to select a preset station.



6 Play

Load discs

You can play video, audio or images stored on the following discs:

- DVD video, DVD-R, DVD-RW
- VCD
- Audio CD, CD-R, CD-RW

Note

- Ensure that the disc contains playable content.

- 1 Insert a disc into the disc slot with the label side facing up.
↳ Play starts automatically.

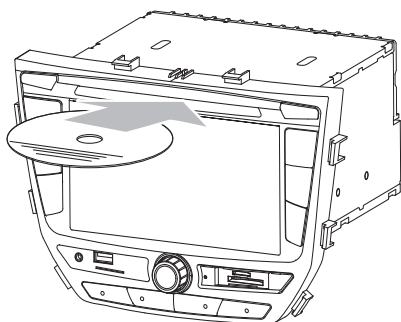

- ↳ To remove the disc, press ▲
- ↳ When the disc is ejected, the unit switches to the previous source, if connected. Otherwise, the unit switches to **[Radio]** mode automatically.

Connect USB device

Note

- Ensure that the device contains playable content.

- 1 Open the AV-IN/USB socket cover.
- 2 Insert the USB device to the USB socket.
↳ Play starts automatically.

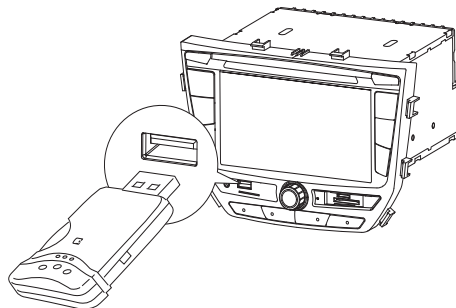

Remove the USB device

- 1 Switch to another (non-USB) source.
- 2 Remove the USB device.

Insert USB or SD/MMC card

Note

- Ensure that the device contains playable content.
- The unit supports SDHC card.

- 1 Open the MAP/SD card socket cover.
- 2 Insert the SD/MMC card into the card slot.
↳ Play starts automatically.

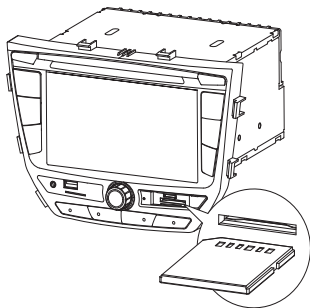

Remove the SD/MMC card

- 1 Switch to another source.
- 2 Press the card until you hear a click sound.
 - ↳ The card is now disengaged.
- 3 Remove the SD or MMC card.

Play/Pause

- 1 Once a disc, USB or SD/MMC card is inserted, play starts automatically.



For DVD movie, if a menu appears, tap a item to start play.

- 2 To pause, tap **⏸**.
 - To resume play, tap **▶**.

Skip/search

- 1 Tap **↶** to return to playlist menu.

- 2 Tap one of below icons to select folder/file:



- **🎵**: To display all available audio folders/track.
 - **🖼️**: To display all available picture folders/files.
 - **🎬**: To display all available video folders/files
- 3 Tap **▲** or **▼** to select a folder/track.
 - 4 Tap **▶** to start play.

Search within a title/folder

Direct search

- 1 Tap anywhere except for the upper left corner to display menu on the screen, if necessary.
- 2 Tap **🔍**.
 - ↳ The search screen is displayed.

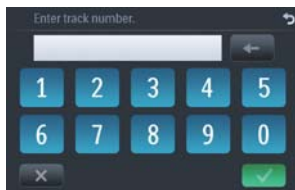

- ↳ For video files, tap **1/2** first, then tap **🔍**.
- 3 Tap the numbers to enter chapter/file number, then tap **✓**.
 - To clear the previous input, tap **↶**.
 - To clear all input, tap **✕**.

Repeat

During play, you can select different repeat play modes.

For DVD/VCD movie disc:

- 1 Tap anywhere except for the upper left corner to display menu on the screen, if necessary.



- 2 Tap **1/2** to display the 2nd menu.







- 3 Tap  to select:
 - **[Repeat chapter]**: play the current chapter repeatedly.
 - **[Repeat title]**: play all chapters in the title repeatedly.
 - **[Repeat off]**: cancel repeat play.

For VCD karaoke:

- 1 Tap  to select:
 - **[Repeat one]**: play the current track repeatedly.
 - **[Repeat all]**: play all tracks repeatedly.
 - **[Repeat off]**: cancel repeat play.

For MP3/WMA files:

- 1 During play, tap  to select:
 - -1: play the current track repeatedly.
 - -Folder: play all the tracks in the current folder repeatedly.
 -  (in grey color): cancel repeat play.



Repeat a section

You can repeat a specific section of video file (repeat A-B).

- 1 During play, tap anywhere except for the upper left corner to display menu on the screen, if necessary.
- 2 Tap **1/2** to display the 2nd menu, if necessary.
- 3 Tap **A-B** repeatedly to mark:
 - **[Repeat A-]**: the start of the section to repeat.
 - **[Repeat A-B]**: the end of the section to repeat.
 - The selected section plays repeatedly.
- 4 To exit A-B repeat mode, tap **A-B** repeatedly until **[Repeat A-B off]** is displayed.

Random play

You can play audio tracks/files in random order.

- 1 During play, tap  repeatedly to turn random play on or off.
 -  is highlighted: start random play.
 -  turns grey: cancel random play.

Select audio language

For video discs that contain two or more audio channels.

- 1 During play, tap anywhere except for the upper left corner to display menu on the screen, if necessary.
- 2 Tap **1/2** to display the 2nd menu.
- 3 Tap  repeatedly.
 - ↳ The audio channel information is displayed on the upper line of the screen.

Select audio mode

When you play VCDs, you can select an audio mode (R/L/Stereo).

- 1 During play, tap anywhere except for the upper left corner to display menu on the screen.
- 2 Tap  repeatedly until the audio mode is selected.

Select subtitle language

For DVD or DivX discs that contain two or more subtitle languages.

- 1 During play, tap anywhere except for the upper left corner to display menu on the screen, if necessary.
- 2 Tap **1/2** to display the 2nd menu
- 3 Tap  repeatedly to select a language.
↳ The selected language is displayed.

Rotate pictures

- 1 When you view pictures, tap anywhere except for the upper left corner to display menu on the screen, if necessary.







- 2 Tap  repeatedly to rotate the picture.

Zoom

You can zoom in pictures for a close view.

- 1 During picture viewing, tap anywhere except for the upper left corner to display menu on the screen, if necessary.
- 2 Tap  repeatedly to zoom in the picture.



- 3 Tap , ,  or  to pan through the enlarged picture.

Select slide show duration

- 1 Tap anywhere except for the upper left corner to display menu on the screen, if necessary.
- 2 Tap  repeatedly to select:
 - **Fast:** 3 seconds
 - **Normal:** 5 seconds
 - **Slow:** 8 seconds

7 Play with Bluetooth device

You can make or receive phone calls with Bluetooth-enabled phones through the unit. You can also listen to music from a Bluetooth-enabled device.

Pair the Bluetooth-enabled devices

To connect your Bluetooth device to the unit, you need to pair the device to the unit. Pairing needs only to be done once. You can pair up to eight devices.

Note



- The operational range between this unit and a Bluetooth device is approximately 10 meters (30 feet).
- Before you connect a Bluetooth device to this unit, familiarize yourself with the Bluetooth capabilities of the device.
- Compatibility with all Bluetooth devices is not guaranteed.
- Any obstacle between this unit and a Bluetooth device can reduce the operational range.
- Keep this unit away from any other electronic device that may cause interference.

- 1 Turn on the Bluetooth function on the device.
- 2 Search for Bluetooth device with the device.
- 3 Select "CID3692" in the pairing list.

- 4 Enter default password "0000".
↳ if pairing succeeds, phone call record is displayed.



Disconnect Bluetooth devices

- 1 To disconnect one device, tap  (red).
↳  (green) is displayed.





Tip

- The device will also be disconnected when the device is moved beyond the operational range.
- If you want to reconnect the device to the unit, place it within the operational range.
- If you do not want to reconnect the device to the unit automatically, tap  > [Auto connect], then select [Off]. For details, see the "Adjust Bluetooth settings" section.

Make a call

- 1 Pair the phone with the unit.
- 2 Tap  to display the home menu.
- 3 Tap [Bluetooth].
↳ The Bluetooth menu is displayed.



- 4 Tap  or  to select the paired phone, then tap .
- 5 Tap  or  to search for phone number from the following list:



- [Missed calls]
- [Received calls]
- [Dialed calls]
- [Phone book]
- [Sim phone book]
- [Local phone book]

Or tap to dial number directly, then tap to dial.

Receive call

By default, all incoming calls are received automatically.

- 1 If there is incoming call, [Incoming call...] flashes on the screen. Speak into the Bluetooth microphone.



- 2 When conversation ends, tap (red) to terminate the call.

Tip

- You can select to receive calls manually by setting [Auto answer] to [Off] status.

Switch phone call to the mobile

If you do not want your passenger to hear your incoming call, you can switch the call to the mobile.

- 1 During talking, tap .

↳ The voice is transferred from the unit's loudspeaker to the mobile phone.

Listen to music from Bluetooth device

If the connected Bluetooth device supports Advanced Audio Distribution Profile (A2DP), you can listen to the music stored on the device through the unit. If the device also supports Audio Video Remote Control Profile (AVRCP) profile, you can use the control on the unit to play music stored in the device.

- 1 Pair the phone with the unit.
- 2 Tap to return to home menu.
- 3 Tap [Bluetooth].
↳ The Bluetooth menu is displayed.
- 4 Start to play music stored in the device.

If your device supports AVRCP,

- 1 Tap .



- 2 Tap to start play.

Adjust Bluetooth settings

You can change below Bluetooth settings:

- [Bluetooth]: to turn on or off "Bluetooth" function
- [Auto connect]: to turn on or off "Auto connect" function
- [Auto answer]: to turn on or off "Auto answer" function
- [Pairing code]: to set pairing code
- [Phone Book Sync]: to synchronize phone book

- 1 In Bluetooth menu, tap .
↳ The option menu is displayed.





- 2 Tap an option to change the setting.

Tip



- You can also adjust Bluetooth settings in the "Settings" menu.

8 Adjust sound

Adjust volume

- 1 Turn /MUTE/VOL button clockwise to increase volume.
- 2 Turn /MUTE/VOL button anti-clockwise to reduce volume.

Mute

- 1 During play, press /MUTE/VOL.
 - To restore the sound, press /MUTE/VOL again.

Tip

- You can also tap  on the screen to turn off sound.

Select preset equalizer

You can select preset equalizer:

- [User]
 - [Techno]
 - [Rock]
 - [Classic]
 - [Jazz]
 - [Optimal]
 - [Flat]
 - [Pop]
- 1 Tap anywhere except for the upper left corner to display menu on the screen, if necessary.
 - 2 Tap .
↳ The current Equalizer setting is displayed.



- 3 Tap ◀ or ▶ to select an EQ.
- 4 Tap ▲ or ▼ to adjust below settings:
 - [Bass] bass range: -14 to +14
 - [Mid] middle range: -14 to +14.
 - [Treb] treble range: -14 to +14
 - [LPH] low pass filter range: 60, 80, 100, 200.
 - [MPF] middle pass filter range: 500, 1K, 1.5K, 2.5K.
 - [HPF] high pass filter range: 10K, 12.5K, 15K, 17.5K.
- 5 Tap ⏪ to restore the above settings into default settings.
- 6 Tap ↶ to exit.

- 5 Tap **F**, **R**, **L**, or **R** to adjust fader/balance value.
 - [Fader] fader range: +24 to -24. (F = front speaker, R = rear speaker)
 - [Balance] balance range: -24 to +24. (L = left speaker, R = right speaker)
- 6 Tap ↶ to exit.

Set Dynamic Bass Boost (DBB)

- 1 Tap **DBB** to toggle between the settings.
 - [DBB] on: The **DBB** icon is illuminated.
 - [DBB] off (default): The **DBB** icon is gray.

Adjust fader/balance

You can also adjust the front and rear speaker balance, the left and right speaker balance, and subwoofer settings.

- 1 Tap anywhere except for the upper left corner to display menu on the screen, if necessary.
- 2 Tap **DBB**.
- 3 Tap **F** ◀ ▶ **R**
 - ↳ Below options are displayed:



- 4 Tap ▲ or ▼ to select subwoofer volume.
 - [Sub] subwoofer volume: 0 to 24.

9 Adjust settings

Display system setup menu

1 Tap to display main menu.



2 Tap in the middle right side of the screen.
 ↳ The second main menu is displayed.

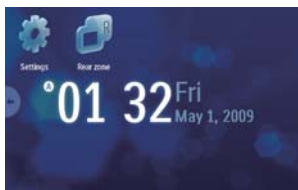

3 Tap **[Settings]**.
 ↳ The settings menu is displayed.

Tip

- When the setup adjustment is completed, tap first and then tap to return to main menu.

Adjust general settings

1 Tap **[General]**, if necessary.



2 Tap or to highlight a setting.

3 Tap on the option to display/select an option.

General settings	Options	Description
[Radio region]	[USA], [S. Amer-1], [Arabia], [China], [S. Amer-2], [Europe], [Korea], [OIRT]	Select one that matches your location.
[Radio range]	[Local]	Only stations with strong signals can be broadcast.
	[Distance]	Stations with strong and weak signals can be broadcast.
[Blackout]	[off]	Never turn on the screen saver.
	[10s]	Turn on the screen saver automatically 10 seconds after last operation.
	[20s]	Turn on the screen saver automatically 20 seconds after last operation.
[Key color]	[Red]	Button backlight turns red.
	[Blue]	Button backlight turns blue.
[Beep]	[On]	Turn on the beep sound. Each time you press a button, the unit beeps.
	[Off]	Turn off the beep sound.
[WallPaper]	[Blue]	Turn background color to blue.
	[Black]	Turn background color to black.

[Red]	Turn background color to red.
[F1]	Select F1 picture as wall paper.
[Calibration]	Calibrate the touch screen.

4 Tap ↩ to exit.

Adjust sound settings

1 Tap [Sound].



2 Tap an option repeatedly to select:

Sound settings	Options	Description
[Sub woofer]	[On]	Turn on the subwoofer.
	[Off]	Turn off the subwoofer.
[Sub woofer filter]	[80Hz]	Select subwoofer filter criteria.
	[120Hz]	
	[160Hz]	
[DBB]	[On]	The Dynamic Bass Boost (DBB) function is on.
	[Off]	The DBB function is off.
[DRC]	[On]	Makes loud sound level softer and soft sound level louder so that you can watch the DVD movies at a low volume, without disturbing others
	[Off]	The DRC function is off.

3 Tap ↩ to exit.

Adjust video settings

1 Tap [Video].



2 Tap an option repeatedly to select:

Video settings	Options	Description
[Aspect ratio]	[Full]	For widescreen display.
	[Normal]	For normal display.
[Video input]	[Auto]	The correct format is set automatically. Select this option if you are not sure which format should be selected.
	[NTSC]	Used in the United States, Canada, Japan, Mexico, the Philippines, South Korea, Taiwan, and some other countries.
	[PAL]	Used in China, India, Singapore, the western European countries (except France), Australia, and some other countries.
	[Secam]	Used in France, Russia and other countries.
[Rear camera]	[Normal]	When you drive in reverse, the rear view is displayed normally.

	[Mirror]	When you drive in reverse, the rear view is displayed in mirror.
[Parking]	[On]	Disable video view during drive.
	[Off]	Enable video view during drive.
[DivX registration code]		View code for DivX registration.

3 Tap ↩ to exit.

Adjust Bluetooth settings

1 Tap [Bluetooth].

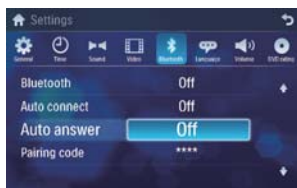

2 Tap an option repeatedly to select:

Bluetooth settings	Options	Description
[Bluetooth]	[On]	Turn on the Bluetooth function.
	[Off]	Turn off the Bluetooth function.
[Auto connect]	[On]	If the pre-paired device is within the effective range, the unit re-connects to pre-paired device automatically.
	[Off]	Need to re-connect manually.
[Auto answer]	[On]	Answer paired phone call automatically.

	[Off]	Answer phone call manually.
[Pairing code]		View code for pairing the unit with other Bluetooth devices.

3 Tap ↩ to exit.

Adjust language settings

1 Tap [Language].

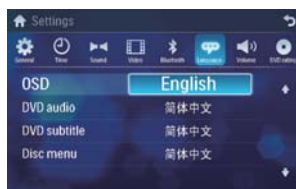

2 Tap an option repeatedly to select:

Language settings	Options	Description
[OSD]	[English]	Select on-screen-display language.
	[简体中文]	
	[繁体中文]	
[DVD audio]	[English]	Select DVD audio language. Options available are depends on DVD disc.
	[简体中文]	
	[繁体中文]	
[DVD subtitle]	[English]	Select DVD subtitle language. Options available are depends on DVD disc.
	[简体中文]	
	[繁体中文]	
	[Off]	Turn off subtitle language display.

[Disc menu]	[English]	Select DVD menu language. Options available are depends on DVD disc.
	[简体中文]	
	[繁体中文]	

3 Tap ↩ to exit.

Adjust volume settings

You can set different volume for different modes.

1 Tap [Volume].
 ↳ The volume setting sub-menu is displayed.



2 Tap on a source.

- [DVD]
- [USB]
- [SDHC]
- [Radio]
- [Bluetooth]
- [AV-IN1]
- [AV-IN2]
- [Navigation]

3 Tap ▲ or ▼ to assign a value: 0 to 12.
 ↳ When you switch to the source, the volume increases automatically.

4 Tap ↩ to exit.

Adjust DVD rating

1 Tap [DVD rating].



2 Tap an option repeatedly to select:

DVD rating	Options	Description
[Set password]		Set password to restrict the play of discs. The default password is 0000.
[Rating level]	[Kid safe]	Acceptable for children.
	[G]	Acceptable for general viewers.
	[PG]	Parental guidance suggested.
	[PG-13]	Unsuitable for children under age 13.
	[PG-R]	Recommend parents to restrict children under 17 to view.
	[R]	Restricted. Recommend parent to guide children under 17 to view.
	[NC-17]	Unsuitable for children under age 17.
	[Adult]	Acceptable for adults only.
[Load factory]		Restore to default settings.

3 Tap ↩ to exit.

10 Others

Listen to other devices

Tip

- When air conditioning information changes, the air conditioning information interface will be displayed for 10 seconds.

You can connect an external audio/video device to the unit.

- 1 Connect the device to the unit with the supplied AV cable.

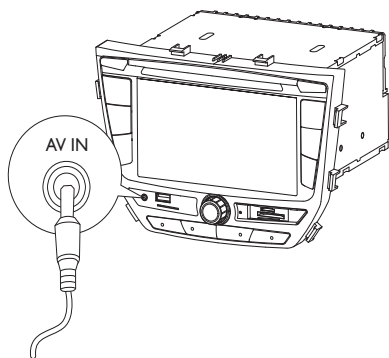

- 2 Tap  to display the main menu.
- 3 Tap [AV-IN1].
- 4 Play the connected device (see the instructions manual of the device).

Tip

- If you connect the system to other audio device through the **REAR OUT L/R** connector (see "Connect wires" section), tap [AV-IN2] to listen to that device.

Reset

When the unit hangs up, you can reset it.

- 1 Open the MAP/SD card socket cover.
- 2 Press the RESET button with a ball-point pen or similar tool.

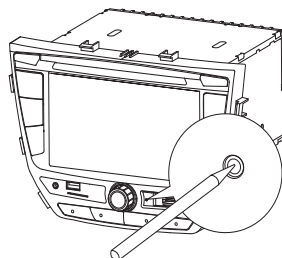

Tip

- When the unit is reset, all the settings remain unchanged.

Remove the unit

To repair, replace fuse, or replace the unit, remove it from the dashboard.

- 1 Screw off the four (4) screws on the left/right side of the unit.
- 2 Pull the unit out from the dashboard.

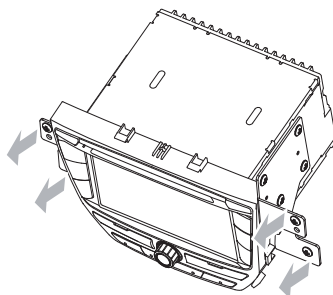

Replace fuse

If there is no power, the fuse may be damaged and need to be replaced.

- 1 Take out the unit from dashboard.
- 2 Check the electric connection.
- 3 Buy a fuse that matches the voltage of the damaged fuse (15A)
- 4 Replace the fuse.

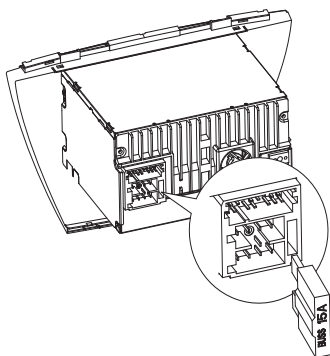

Note

- If the fuse gets damaged immediately after it has been replaced, there may be an internal malfunction. In such case, consult your Philips dealer.

11 Product information

Note

- Product information is subject to change without prior notice.

General

Power supply	12 V DC (11 V - 16 V), negative ground
Fuse	15 A
Suitable speaker impedance	4 - 8 Ω
Maximum power output	50 W x 4 channels
Continuous power output	24 W x 4 channels (4 Ω 10% T.H.D.)
Pre-Amp output voltage	2.0 V (CD play mode; 1 kHz, 0 dB, 10 k Ω load)
Subwoofer output voltage	2.0 V (CD play mode, 61 Hz, 0 dB, 10 k Ω load)
Aux-in level	\geq 500 mV
Dimensions (W x H x D)	228.4 x 161.5 x 186 mm
Weight (main unit)	2.3 kg

Disc player

System	DVD / CD audio / MP3 system
Frequency response	20 Hz - 20k Hz
Signal/noise ratio	>75dB
Total harmonic distortion	Less than 1%
Channel separation	>55dB
Video signal format	NTSC only
Video output	1 +/- 0.2V

Tuner

Frequency range - FM	87.5 - 108.0 MHz (Europe)
Frequency range - AM(MW)	522 - 1620 KHz (Europe)
Usable sensitivity - FM	5 μ V
Usable sensitivity - AM (MW)	50 μ V

LCD

Screen size	8 inches (16:9)
Display resolution	800 x 480 dots
Contrast ratio	300
Brightness	350 cd/m ²

Bluetooth

Communication system	Bluetooth Standard version 2.0
Output	Bluetooth Standard Power Class 2
Maximum communication range	Line of sight approx. 8m
Frequency band	2.4 GHz band (2.4000 GHz - 2.4835 GHz)
Compatible Bluetooth profiles	Hands-Free Profile (HFP) Handset Profile (HSP) Advanced Audio Distribution Profile (A2DP) Audio Video Remote Control Profile (AVRCP)
Supported codecs	
Receive	SBC (Sub Band Codec)
Transmit	SBC (Sub Band Codec)

Compatible USB devices:

- USB flash memory (USB 2.0 or USB1.1)
- USB flash players (USB 2.0 or USB1.1)
- Memory cards (SD / MMC / SDHC)

Supported formats:

- USB or memory file format: FAT16, FAT32
- MP3 bit rate (data rate): 32-320 Kbps and variable bit rate
- WMA v9 or earlier
- Directory nesting up to a maximum of 8 levels
- Number of albums/ folders: maximum 99
- Number of tracks/titles: maximum 999
- ID3 tag V2.0 to V2.4
- File name in Unicode UTF8 (maximum length: 128 bytes)

Supported MP3 disc format:

- ISO9660, Joliet
- Maximum title number: 512 (depending on file name length)
- Maximum album number: 255
- Supported sampling frequencies: 32 kHz, 44.1kHz, 48 kHz
- Supported Bit-rates: 32-320 Kbps and variable bit rate

Supported video formats:

- DVD
- Divx Home theater
- Xvid



Note

To ensure a better playback, it is recommended that:

- the image size is not larger than 640 X 480 pixels.
- the frame rate is 20 fps.
- the data rate is not higher than 500 kbps.

12 Troubleshooting



Warning

- Never remove the casing of this apparatus.

To keep the warranty valid, never try to repair the system yourself.

If you encounter problems when using this apparatus, check the following points before requesting service. If the problem remains unsolved, go to the Philips web site (www.philips.com/welcome). When you contact Philips, ensure that the apparatus is nearby and the model number and serial number are available.

No power

- Car engine has not been started. Start the car engine.
- Connections is incorrect.
- Fuse has been damaged. Replace fuse.

No sound

- Volume is too low. Adjust volume.
- Speaker connections is incorrect.

Disc does not play

- Disc is upside down. Ensure the printed side is upwards.
- Disc is dirty. Clean the disc with a clean, soft, lint-free cloth. Wipe the disc outwards from the center.
- Disc is defective. Try another disc.
- incompatible disc is used. Try another disc.
- Disc rating exceeds the restrict setting. Change the rating settings to lower one.
- Disc region code is not compatible with the unit. Use disc with proper region code.

No image

- Parking brake wire connection is incorrect. Check the parking wiring.

Image flashes or distorted

- Video DVD settings do not match with the DVD. Adjust video DVD settings.
- Video connection is improper. Check the connections.

Noise in broadcasts.

- Signals are too weak. Select other stations with stronger signals.
- Check the connection of the car antenna.
- Change broadcast from stereo to mono.

Preset stations lost.

- Battery cable is not correctly connected. Connect the battery cable to the terminal that is always live.

Fuse is broken

- The Fuse type is incorrect. Replace it with a 15A fuse.
- Speaker wire or power wire is grounded. Check the connections.

Display show ERR-12

- USB/SD/MMC data error. Check the USB device or SD/MMC card.

About Bluetooth device

Music playback is unavailable on the system even after successful Bluetooth connection.

- The device cannot be used with the system to play music.

The audio quality is poor after connection with a Bluetooth-enabled device.

- The Bluetooth reception is poor. Move the device closer to the system or remove any obstacle between the device and the system.

Cannot connect with the system.

- The device does not support the profiles required for the system.

- The Bluetooth function of the device is not enabled. Refer to the user manual of the device for how to enable the function.
- The system is not in the pairing mode.
- The system is already connected with another Bluetooth-enabled device. Disconnect that device or all other connected devices and then try again.

The paired mobile phone connects and disconnects constantly.

- The Bluetooth reception is poor. Move the mobile phone closer to the system or remove any obstacle between the mobile phone and the system.
- Some mobile phones may connect and disconnect constantly when you make or end calls. This does not indicate any malfunction of the system.
- For some mobile phones, the Bluetooth connection may be deactivated automatically as a power-saving feature. This does not indicate any malfunction of the system.

13 Glossary

B

Bite rate

The max data transfer through the USB port.

Bluetooth

Bluetooth® is a short-rang wireless protocol that is meant to allow mobile devices to share information and applications without the worry of cables or interface incompatibilities. The name refers to a Viking King who unified Denmark. Operate at 2.4GHz. For more information, see www.bluetooth.com.

M

MMC

MultimediaCard. A type of memory card with a flash memory.

MP3

A file format with a sound data compression system. MP3 is the abbreviation of Motion Picture Experts Group 1 (or MPEG-1) Audio Layer 3. With the MP3 format, one CD-R or CD-RW can contain about 10 times more data than a regular CD.

R

Region code

A system that allows discs to be played only in the region designated. This unit only plays discs that have compatible region codes. You can find the region code of your unit on the product label. Some discs are compatible with more than one region (or ALL regions.)

S

SD

Secure Digital. A type of memory card with a flash memory.

SDHC

Secure Digital High Capacity (SDHC) is a type of flash memory card based on the SDA 2.00 specification. The SDA 2.00 specification enables SD cards to reach higher capacities from 4GB to 32GB, and growing.

W

WMA (Windows Media Audio)

An audio format owned by Microsoft, is a part of Microsoft Windows Media technology. Includes Microsoft Digital Rights Management tools, Windows Media Video encoding technology, and Windows Media Audio encoding technology.

